

Material: Sinterbronze
 Filterfeinheit: 50µ
 Betriebsdruck: max. 10 bar
 Betriebstemperatur: -10°C bis +150°C
 zyl. Gewinde: DIN EN ISO 228
 metr. Gewinde: DIN EN ISO 262

material: sintered bronze
 filter mesh: 50µ
 working pressure: max. 10 bar
 working temperature: -10°C up to +150°C
 cyl. threads: DIN EN ISO 228
 metr. threads: DIN EN ISO 262

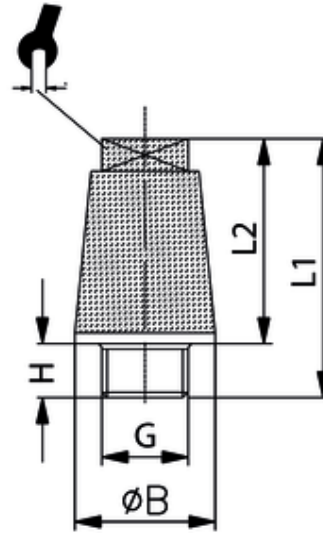

ITV	G	ØB	H	L2	L1	SW
303023	G1/4	15	6	19	25	8