

1/3-Verschraubung

Hose connector 1/3

Betriebstemperatur: max. 150°C
Betriebsdruck: bis 60bar
Werkstoff: Messing vernickelt/ blank CW614N und CW617N
Gewinde: zyl. Gewinde DIN 3852
 kon. Gewinde DIN 3858
Medium: Luft, Wasser, Öl, Dampf, etc.

Operating temperature: max. 150°C
Operating pressure: up to 60bar
Material: brass nickel-plated/ polished CW614N and CW617N
Thread: cyl. thread DIN 3852
 con. thread DIN 3858
Medium: Air, water, oil, steam, etc.

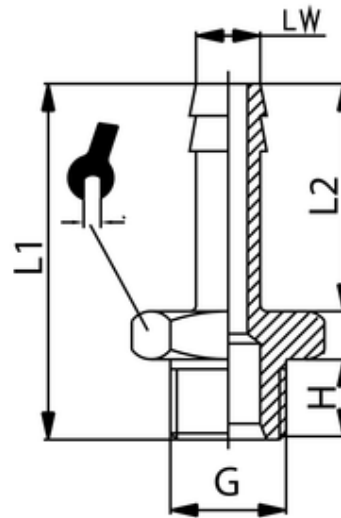

ITV	LW	G	H	L2	L1	SW
401063	32	G1 1/4	13	39	57,5	50