

# Reduzierung

Reduzierung  
Reducer

**Betriebstemperatur:** max. 150°C  
**Betriebsdruck:** bis 60bar  
**Werkstoff:** Messing vernickelt/ blank CW614N und CW617N  
**Gewinde:** zyl. Gewinde DIN 3852  
 kon. Gewinde DIN 3858

**Operating temperature:** max. 150°C  
**Operating pressure:** up to 60bar  
**Material:** brass nickel-plated/ polished CW614N and CW617N  
**Thread:** cyl. thread DIN 3852  
 con. thread DIN 3858  
*Medium:* Air, water, oil, steam, etc.

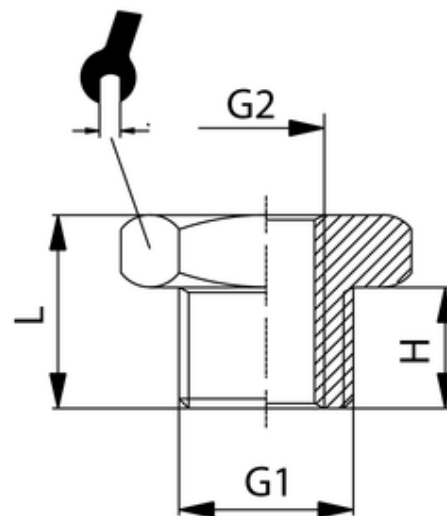

ITV	G1	G2	H	L	SW
401314	G1	G3/8	15	23	41