

Winkel 90° I-A

Elbow 90° F-M

Betriebstemperatur: max. +200°C
Betriebsdruck: bis 16bar
Werkstoff: Edelstahl AISI 316
Gewinde: zyl. Gewinde DIN 3852
 kon. Gewinde DIN 3858

Operating temperature: max. +200°C
Operating pressure: up to 16bar
Material: Stainless steel AISI 316
Thread: cyl. thread DIN 3852
 con. thread DIN 3858

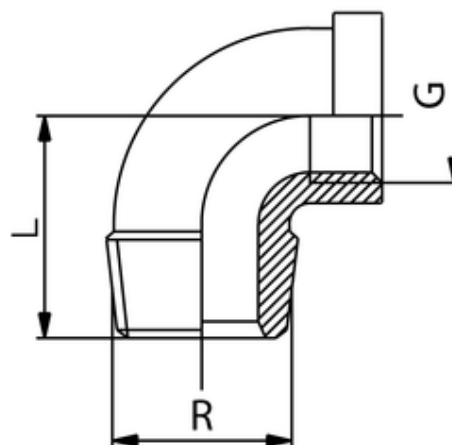

ITV	G	R	L
85209	G1 1/2	R1 1/2	47