

Kugelhahn

Ball valve
Valvola a sfera

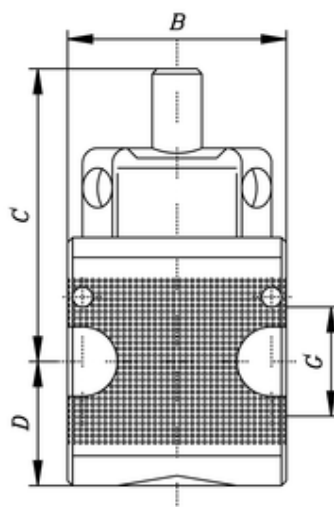

ITV	G	NI/min	B	C	D
120301	G1/4	2.800	48	57	26

Betriebsdruck:	16 bar
Inlet pressure:	16 bar
Pressione di esercizio:	16 bar
max. Temperatur bei 10 bar:	+60 °C
max. temperature at 10 bar:	+60 °C
Temperatura max a 10 bar:	+60 °C
Einbauposition:	beliebig
Mounting position:	any position
Posizione di montaggio:	in qualsiasi posizione
Betätigung:	Knebel
Operation:	T-handle
Azionamento:	manopola
Befestigung:	Winkel oder 2 Bohrungen
Fortify:	elbow or 2 drillings
Fissaggio:	staffa o 2 fori