

Präzisions-Druckminderer

Precision pressure regulator
Riduttore di precisione

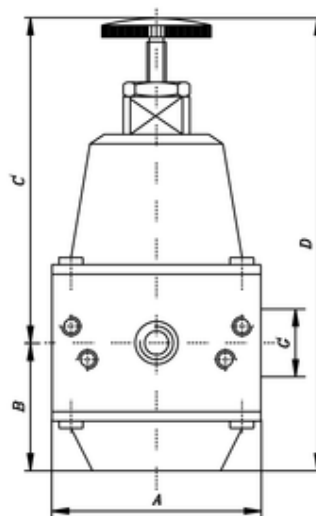

ITV	G	NI/min	A	B	C	D	ELV	P*
120404	G1/4	950	58	17	102	119	4,1	0,05-7

Manometeranschluss:	1/4"
Pressure gauge thread:	1/4"
Attacco manometro (filetto):	1/4"
Betriebsdruck:	16 bar
Inlet pressure:	16 bar
Pressione di ingresso:	16 bar
max. Temperatur bei 10 bar:	+60 °C
max. temperature at 10 bar:	+60 °C
Temperatura max a 10 bar:	+60 °C
Einbauposition:	beliebig
Mounting position:	any position
Posizione di montaggio:	in qualsiasi posizione
Befestigung:	Winkel oder 2 Bohrungen
Fortify:	elbow or 2 drillings
Fissaggio:	staffa o 2 fori

ELV Eigenluftverbrauch l/min. - own air use l/min. - consumo di aria propria l/min. P* Ausgangsdruck bar - outlet pressure bar - pressione di uscita bar