

REG

Regler
 Pressure regulator
 Riduttore die pressione

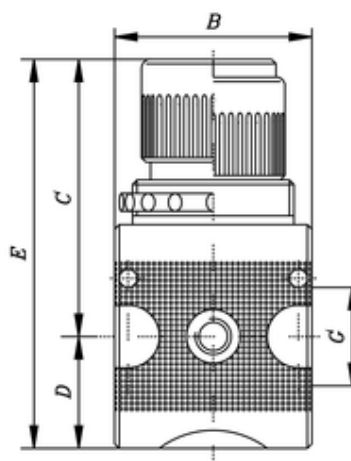

ITV	G	NI/min	B	C	D	E
130201	G3/8	1.500	48	67	27	94

Ohne Manometer

Without manometer

Senza manometro

Manometeranschluss	1/4"
Pressure gauge thread	1/4"
Attacco manometro (filetto)	1/4"
Regelbereich	0,5-10 bar
Pressure adjusting range	0,5-10 bar
Campo di regolazione	0,5-10 bar
max. Betriebsdruck	16 bar
max. Inlet pressure	16 bar
Pressione max di ingresso	16 bar
max. Temperatur bei 10 bar	+60 °C
max. temperature at 10 bar	+60 °C
Temperatura max a 10 bar	+60 °C
Einbauposition	beliebig
Mounting position	any position
Posizione di montaggio	in qualsiasi posizione
Medium	Luft
Fluid	air
Fluido di passaggio	aria
Befestigung	Winkel oder 2 Bohrungen
Fortify	elbow or 2 drillings
Fissaggio	staffa o 2 fori