

# Filterregler + Öler

Filter regulator + lubricator  
Filtro regolatore + Lubrificatore

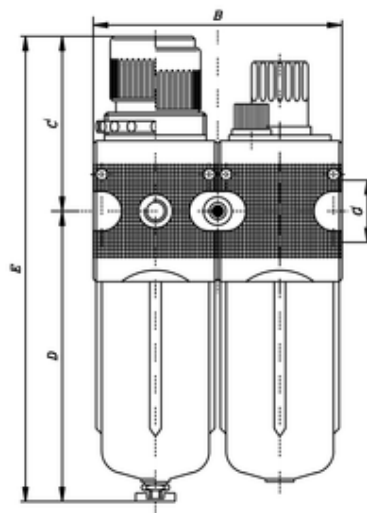

ITV	G	NI/min	B	C	D	E	BG*	BGÖ*
152510	G3/4	3.500	136	97	151	248	50	125

ohne Manometer  
without manometer  
senza manometro

Manometeranschluss	1/4"
Pressure gauge thread	1/4"
Attacco manometro (filetto)	1/4"
max. Betriebsdruck	16 bar
max. Inlet pressure	16 bar
Pressione max di esercizio	16 bar
max. Temperatur bei 10 bar	+60 °C
max. temperature at 10 bar	+60 °C
Temperatura max a 10 bar	+60 °C
Einbauposition	vertikal
Mounting position	vertically
Posizione di montaggio	verticalmente
Kondensatablass	manuell
Drainage system	manual
Sistema di drenaggio	manuale
Abscheidegrad	40 µ
Degree of filtration	40 µ
Grado di filtrazione	40 µ
Öldosierung	1-2 Tropfen/min.
Oil quote	1-2 drops/min.
Dosaggio dell'olio	1-2 gocce/min.
Medium	Luft
Fluid	air
Fluido di passaggio	aria
Befestigung	Winkel oder 2 Bohrungen
Fortify	elbow or 2 drillings
Fissaggio	staffa o 2 fori

BG\* - Behältergröße /cm<sup>3</sup> - Bowl capacity /cm<sup>3</sup> - Capacità della tazza /cm<sup>3</sup> BGÖ\* - Behältergröße Öler /cm<sup>3</sup> - Bowl capacity lubricator/cm<sup>3</sup> - Capacità della tazza lubrificatore /cm<sup>3</sup>