

ipso 048 - Basic

Rückschlagventil, pneumatisch entsperrbar
Check valve
 Valvola di blocco unidirezionale

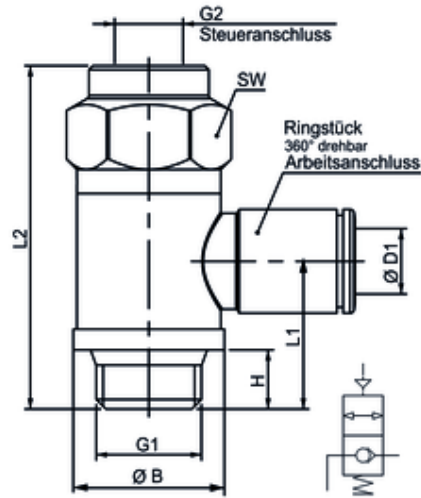

ITV	ØD1	G1	G2	ØB	H	L1	L2	sw	NI/min*
204817	8	G1/8	M5	14	6	15,5	35	14	280

Körper:	CW614N/CW617N vernickelt
Body:	CW614N/CW617N nickel-plated
Corpo:	ottone CW614N/CW617N nichelato
Dichtung:	NBR
Sealing:	NBR
Guarnizione:	NBR 70 SH
Flachdichtungen:	Kunststoff
Flat-seals:	Plastics
Rondella di tenuta sul filetto:	Tecnopolimero
Feder:	AISI 302
Spring:	AISI 302
Molla:	AISI 302
zyl. Gewinde:	DIN EN ISO 228
cyl. Threads:	DIN EN ISO 228
Filettatura:	gas cilindrica ISO 228
Betriebstemperatur:	-20 °C bis +80 °C
Working temperature:	-20 °C up to +80 °C
Temperatura di esercizio:	da -20 °C a +80 °C
Betriebsdruck:	0,5 - 10 bar
Working pressure:	0,5 - 10 bar
Pressione di esercizio:	da 0,5 a 10 bar
Öffnungsdruck:	0,2 bar
Opening pressure:	0,2 bar
Pressione die apertura:	0,2 bar
Für geölte und ungeölte Druckluft.	
For lubricated and non-lubricated compressed air.	
Per aria compressa sia lubrificata che non.	