

ipso 053

Drosselrückschlagventil mit Ringstück, Typ B, Abluft
drosselbar
Unidirectional flow regulator type B

Körper: CW617N vernickelt
O-Ring: NBR
zyl. Gewinde: DIN EN ISO 228
Betriebstemperatur: -20°C bis +80°C
Betriebsdruck: max. 10 bar

Body: CW617N nickel-plated
O-Rings: NBR
cyl. Threads: DIN EN ISO 228
Working temperature: -20°C up to +80°C
Working pressure: max. 10 bar

für geölte und ungeölte Druckluft

for lubricated and non-lubricated compressed air

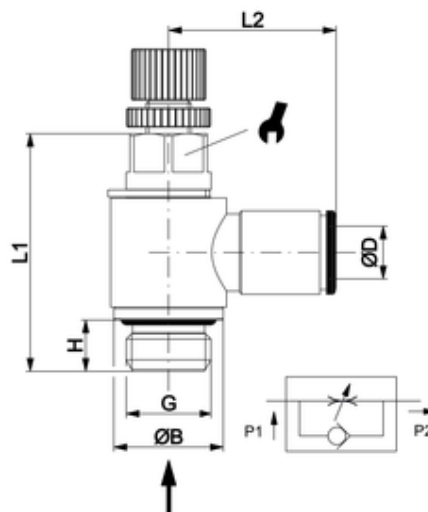

ITV	ØD	G	H	ØB	L1	L2	sw	NI/min *
205310	10	G1/4	8	17	37	27	12	810

*Ermittlung der Durchflusswerte bei 6 bar / Evaluation of flow rate at 6 bar