

# Reduzierung, konisch

Reducer, conical

Riduzione M.F. conica

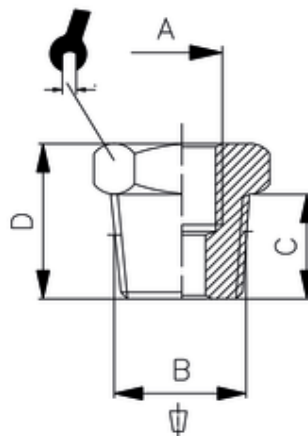

ITV	A	B	C	D	sw
20805-ES	G1/4	R1/2	14	20	22

**Betriebstemperatur:** -20 °C bis +150 °C

**Betriebsdruck:** bis 150 bar

**Werkstoffe:** Edelstahl 1.4404 (AISI 316L)

Dichtungen FKM

**Gewinde:** DIN 3852

DIN 3858

**Einsatzbereiche:** Pneumatik, Nahrungsmittelindustrie, chem. u. pharm. Industrie

**Operating temperature:** -20 °C to +150 °C

**Operating pressure:** up to 150 bar

**Materials:** Stainless steel 1.4404 (AISI 316L)

Seals FKM

**Thread:** DIN 3852

DIN 3858

**Application:** Pneumatics, food industry, chemical and pharmaceutical industry