

Muffe

Sleeve

Manicotto filettato F.F.

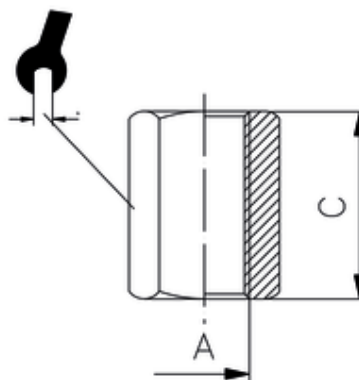
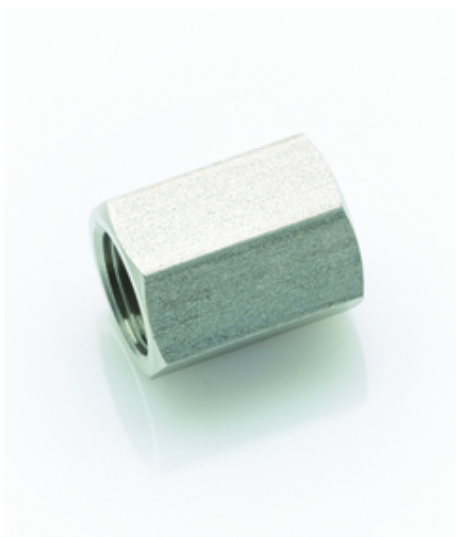

ITV	A	C	sw
30002-ES	G1/8	15	14

Betriebstemperatur:	-20 °C bis +150 °C
Betriebsdruck:	bis 150 bar
Werkstoffe:	Edelstahl 1.4404 (AISI 316L)
Gewinde:	Dichtungen FKM DIN 3852 DIN 3858
Einsatzbereiche:	Pneumatik, Nahrungsmittelindustrie, chem. u. pharm. Industrie
Operating temperature:	-20 °C to +150 °C
Operating pressure:	up to 150 bar
Materials:	Stainless steel 1.4404 (AISI 361L)
Thread:	Seals FKM DIN 3852 DIN 3858
Application:	Pneumatics, food industry, chemical and pharmaceutical industry