

## Schalldämpfer

### Silencer

Silenziatore con pastiglia in sinterizzato

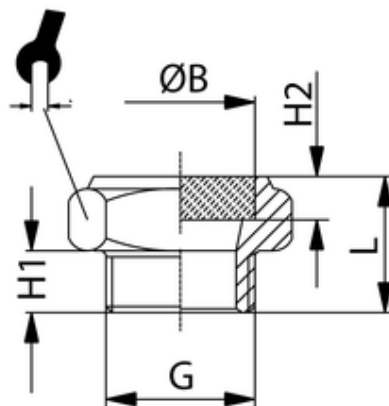

ITV	G	ØB	H1	H2	L	sw
303034	G3/8	17	9	4	18	19

Körper:	Messing
Body:	brass
Corpo:	ottone
Filter:	Sinterbronze
Filter:	sintered bronze
Filtro:	bronzo sferico sinterizzato
Filterfeinheit:	120 µ
Filter mesh:	120 µ
Elemento filtrante:	120 µ
Betriebsdruck:	max. 10 bar
Working pressure:	max. 10 bar
Pressione di esercizio:	max. 10 bar
Betriebstemperatur:	-20 °C bis +150 °C
Working temperature:	-20 °C up to +150 °C
Temperatura di esercizio:	da -20 °C a +150 °C
zyl. Gewinde:	DIN EN ISO 228
cyl. threads:	DIN EN ISO 228
Filettatura:	DIN EN ISO 228
metr. Gewinde:	DIN EN ISO 262
metr. threads:	DIN EN ISO 262
Filettatura metrica:	DIN EN ISO 262