

SEM

Schalldämpfer

Silencer

Silenziatore corto con nipplo in ottone

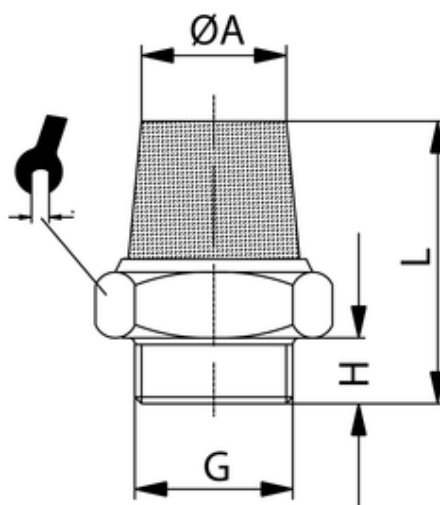

ITV	G	ØA	H	L	SW
303046	G3/4	22	13	39	30

Material:	Sinterbronze & Messing
material:	sintered bronze & brass
Materiale:	Bronzo sferico sinterizzato e ottone
Filterfeinheit:	50 µ
filter mesh:	50 µ
Elemento filtrante:	50 µ
Betriebsdruck:	max. 10 bar
working pressure:	max. 10 bar
Pressione di esercizio:	max. 10 bar
Betriebstemperatur:	-20 °C bis +150 °C
working temperature:	-20 °C up to +150 °C
Temperatura di esercizio:	da -20 °C a +150 °C
zyl. Gewinde:	DIN EN ISO 228
cyl. threads:	DIN EN ISO 228
Filettatura:	DIN EN ISO 228
metr. Gewinde:	DIN EN ISO 262
metr. threads:	DIN EN ISO 262
Filettatura metrica:	DIN EN ISO 262