

Schalldämpfer
Silencer
Silenziatore con nipplo in ottone

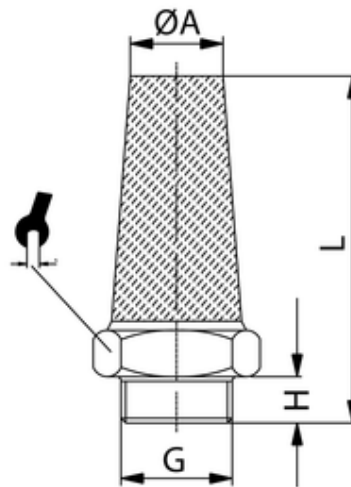

ITV	G	ØA	H	L	sw
303052	G1/8	7,5	6	26	13

Material:	Sinterbronze & Messing
material:	sintered bronze & brass
Materiale:	Bronzo sferico sinterizzato e ottone
Filterfeinheit	50 µ
filter mesh:	50 µ
Elemento filtrante:	50 µ
Betriebsdruck:	max. 10 bar
working pressure:	max. 10 bar
Pressione di esercizio:	max. 10 bar
Betriebstemperatur:	-20 °C bis +150 °C
working temperature:	-20 °C up to +150 °C
Temperatura di esercizio:	da -20 °C a +150 °C
zyl. Gewinde:	DIN EN ISO 228-1
cyl. threads:	DIN EN ISO 228-1
Filettatura	DIN EN ISO 228-1
metr. Gewinde:	DIN EN ISO 262
metr. threads:	DIN EN ISO 262
Filettatura metrica	DIN EN ISO 262