

SESchalldämpfer
Silencer

Material: Sinterbronze & Messing
 Filterfeinheit: 50 μ
 Betriebsdruck: max. 10 bar
 Betriebstemperatur: -20°C bis +150°C
 zyl. Gewinde: DIN EN ISO 228-1
 metr. Gewinde: DIN EN ISO 262

material: sintered bronze & brass
 filter mesh: 50 μ
 working pressure: max. 10 bar
 working temperature: -20°C up to +150°C
 cyl. threads: DIN EN ISO 228-1
 metr. threads: DIN EN ISO 262

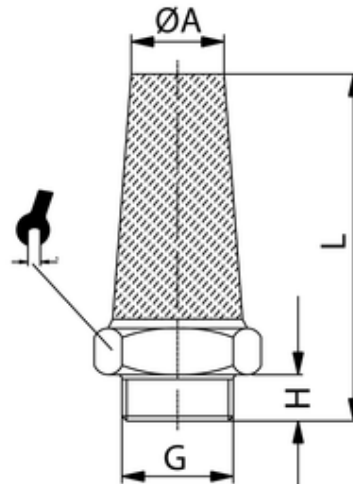

<i>ITV</i>	<i>G</i>	<i>ØA</i>	<i>H</i>	<i>L</i>	<i>SW</i>
303055	G1/2	16	9	45	24