

Schalldämpfer
Silencer
Silenziatore con filo inox

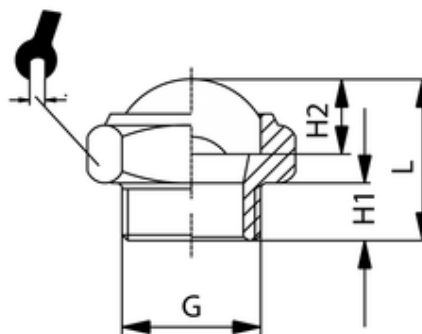

ITV	G	H1	H2	L	sw
303106	G3/4	10	4	27	30

Körper:	Sinterbronze & Messing
body:	sintered bronze & brass
Corpo:	Ottone
Filter:	Edelstahl AISI 304L
Filter:	Inox AISI 304L
Filtro:	Inox AISI 304L
Filterfeinheit:	70 µ
Filter mesh:	70 µ
Elemento filtrante:	70 µ
Betriebsdruck:	max. 10 bar
working pressure:	max. 10 bar
Pressione di esercizio:	max. 10 bar
Betriebstemperatur:	-20 °C bis +150 °C
working temperature:	-20 °C up to +150 °C
Temperatura di esercizio:	da -20 °C a +150 °C
zyl. Gewinde:	DIN EN ISO 228
cyl. threads:	DIN EN ISO 228
Filettatura:	DIN EN ISO 228
metr. Gewinde:	DIN EN ISO 262
metr. threads:	DIN EN ISO 262
Filettatura metrica:	DIN EN ISO 262