

SVESchalldämpfer
Silencer

Material:
 Körper: Messing
 Filter: Sinterbronze
 Feder: Edelstahl
 Dichtung: NBR
 Filterfeinheit: 36 μ
 Betriebsdruck: max. 10 bar
 Betriebstemperatur: -20°C bis +70°C
 zyl. Gewinde: DIN EN ISO 228

material:
 body: brass
 filter: sintered bronze
 spring: stainless steel
 seal: NBR
 filter mesh: 36 μ
 working pressure: max. 10 bar
 working temperature: -20°C to +70°C
 cyl. threads: DIN EN ISO 228

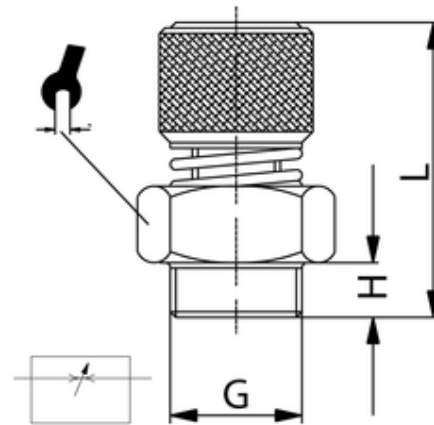

<i>ITV</i>	<i>G</i>	<i>H</i>	<i>L min.</i>	<i>L max.</i>	<i>SW</i>
303123	G1/4	8	30	32	15