

Schalldämpfer

Silencer

Silenziatore con regolazione di scarico

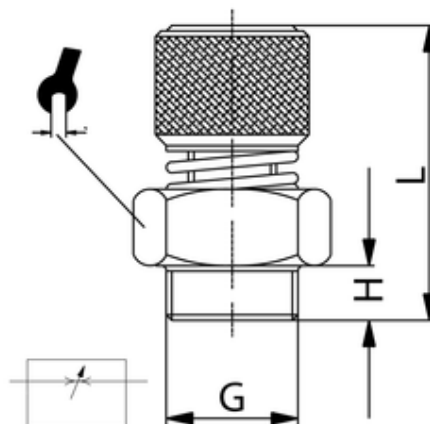

ITV	G	H	L min.	L max.	sw
303125	G1/2	11	36	39	22

Körper:	Messing
Body:	brass
Corpo:	ottone
Dichtung:	NBR
Seal:	NBR
Guarnizioni:	NBR
Feder:	Edelstahl
Spring:	stainless steel
Molla:	Inox
Filter:	Sinterbronze
Filter:	sintered bronze
Filtro:	bronzo sferico sinterizzato
Filterfeinheit:	36 μ
Filter mesh:	36 μ
Elemento filtrante:	36 μ
Betriebsdruck:	max. 10 bar
Working pressure:	max. 10 bar
Pressione di esercizio:	max. 10 bar
Betriebstemperatur:	-20 °C bis +70 °C
Working temperature:	-20 °C up to +70 °C
Temperatura di esercizio:	da -20 °C a +70 °C
zyl. Gewinde:	DIN EN ISO 228
cyl. threads:	DIN EN ISO 228
Filettatura:	DIN EN ISO 228