

Schalldämpfer - Edelstahl
 Silencer - INOX
 Silenziatore in Acciaio

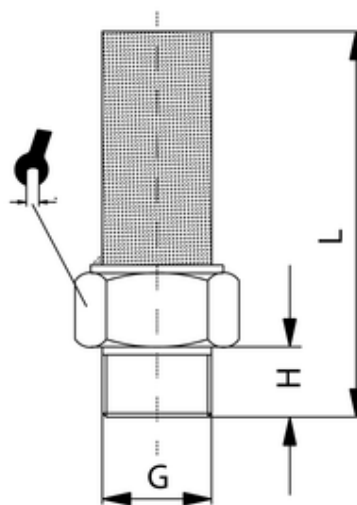

ITV	G	H	L	sw
303152	G1/8	6	25	13

Material:	Edelstahl AISI 316L
material:	Inox AISI 316L
Materiale:	Inox AISI 316L
Betriebsdruck:	max. 12 bar
working pressure:	max. 12 bar
Pressione di esercizio:	max. 12 bar
Betriebstemperatur:	-10 °C bis +400 °C
working temperature:	-10 °C up to +400 °C
Temperatura di esercizio:	da -10 °C a +400 °C
zyl. Gewinde:	DIN EN ISO 228
cyl. threads:	DIN EN ISO 228
Filettatura	DIN EN ISO 228
metr. Gewinde:	DIN EN ISO 262
metr. threads:	DIN EN ISO 262
Filettatura metrica	DIN EN ISO 262