

Schalldämpfer - Edelstahl
 Silencer - INOX
 Silenziatore in Acciaio

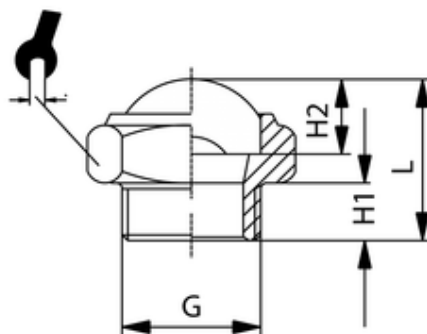

ITV	G	H1	H2	L	sw
303163	G1/4	9	4	19	16

Material:	Edelstahl AISI 316L
Material:	Inox AISI 316L
Materiale:	Inox AISI 316L
Filterfeinheit:	70 µ
Filter mesh:	70 µ
Elemento filtrante:	70 µ
Betriebsdruck:	max. 10 bar
Working pressure:	max. 10 bar
Pressione di esercizio:	max. 10 bar
Betriebstemperatur:	-20 °C bis +300 °C
Working temperature:	-20 °C up to +300 °C
Temperatura di esercizio:	da -20 °C a +300 °C
zyl. Gewinde:	DIN EN ISO 228
cyl. threads:	DIN EN ISO 228
Filettatura:	DIN EN ISO 228
metr. Gewinde:	DIN EN ISO 262
metr. threads:	DIN EN ISO 262
Filettatura metrica:	DIN EN ISO 262