

# Schottverschraubung

Schottverschraubung  
Bulkhead union

**Betriebstemperatur:** -20°C bis +150°C  
**Betriebsdruck:** bis 150 bar  
**Werkstoffe:** Edelstahl 1.4404 (AISI 316L)  
 Dichtungen FKM  
**Gewinde:** DIN 3852  
 DIN 3858  
**Einsatzbereiche:** Pneumatik, Nahrungsmittelindustrie, chem. u. pharm. Industrie

**Operating temperature:** -20°C to +150°C  
**Operating pressure:** up to 150 bar  
**Materials:** Stainless steel 1.4404 (AISI 316L)  
 Seals FKM  
**Thread:** DIN 3852  
 DIN 3858  
**Application:** Pneumatics, food industry, chemical and pharmaceutical industry

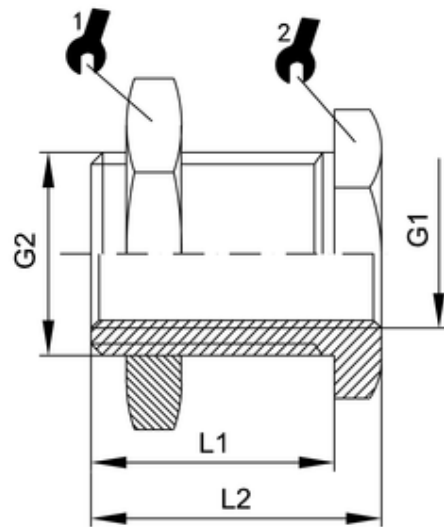

ITV	G1	G2	L1	L2	sw1	sw2
30603-ES	G1/4	M20x1,5	21	25	27	24