

Doppelnippel lösbar, vernickelt

konisch

Detachable conical double nipple, nickel-plated

Nipplo M.M. conico orientabile, nichelato

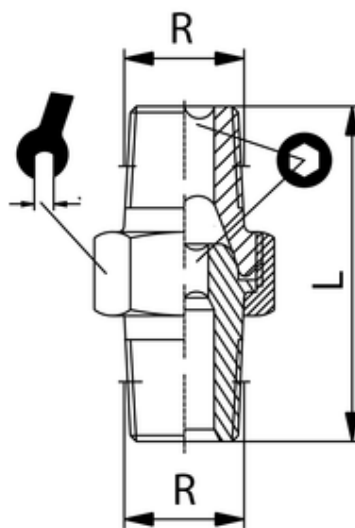

ITV	R	L	sw	isw
306032	R1/8	27,5	15	5

Betriebstemperatur:	max. 150°C
Betriebsdruck:	bis 60bar
Werkstoff:	Messing vernickelt/ blank CW614N und CW617N
Gewinde:	zyl. Gewinde DIN 3852 kon. Gewinde DIN 3858
Medium:	Luft, Wasser, Öl, Dampf, etc.

Operating temperature:	max. 150°C
Operating pressure:	up to 60bar
Material:	brass nickel-plated/ polished CW614N and CW617N
Thread:	cyl. thread DIN 3852 con. thread DIN 3858
Medium:	Air, water, oil, steam, etc.