

Schottverschraubung

Schottverschraubung
Bulkhead union

Betriebstemperatur: -20°C bis +150°C
Betriebsdruck: bis 150 bar
Werkstoffe: Edelstahl 1.4404 (AISI 316L)
 Dichtungen FKM
Gewinde: DIN 3852
 DIN 3858
Einsatzbereiche: Pneumatik, Nahrungsmittelindustrie, chem. u. pharm. Industrie

Operating temperature: -20°C to +150°C
Operating pressure: up to 150 bar
Materials: Stainless steel 1.4404 (AISI 316L)
 Seals FKM
Thread: DIN 3852
 DIN 3858
Application: Pneumatics, food industry, chemical and pharmaceutical industry

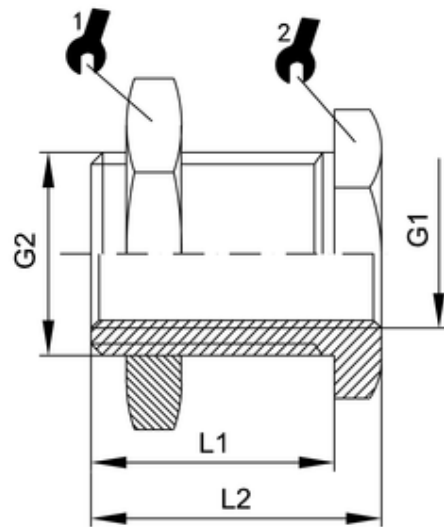

ITV	G1	G2	L1	L2	sw1	sw2
30604-ES	G3/8	M26x1,5	21	26	32	30