

Drosselrückschlagventil Kunststoff

Steck-, Einschraubanschluss
Acetal line flow regulator

Körper: Kunststoff
O-Ring: NBR
zyl. Gewinde: DIN EN ISO 228
Betriebstemperatur: -20°C bis +70°C
Betriebsdruck: max. 10 bar

Body: Plastics
O-Rings: NBR
cyl. Threads: DIN EN ISO 228
Working temperature: -20°C up to +70°C
Working pressure: max. 10 bar

für geölte und ungeölte Druckluft

for lubricated and non-lubricated compressed air

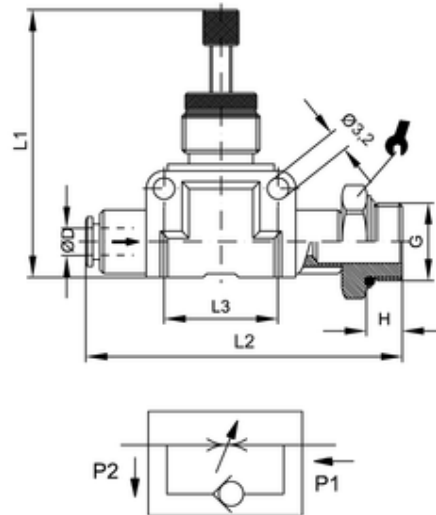

ITV	ØD	G	H	L1	L2	L3	sw	NI/min *
350402	6	G1/8	5	45	52	16	13	260

*Ermittlung der Durchflusswerte bei 6 bar / Evaluation of flow rate at 6 bar

für Zuluft / for Valves