

1/3-Verschraubung

Hose connector 1/3

Portagomma maschio cilindrico

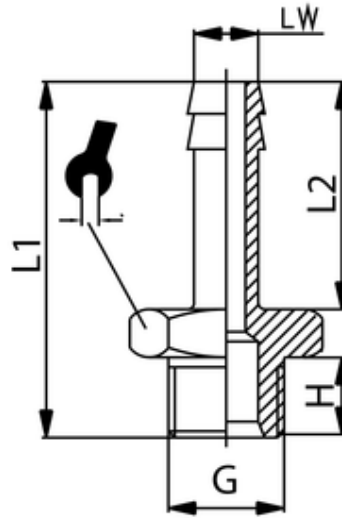

ITV	LW	G	H	L2	L1	sw
401024	9	G3/8	9	22	36	19

Betriebstemperatur:	max. 150°C
Betriebsdruck:	bis 60bar
Werkstoff:	Messing vernickelt/ blank CW614N und CW617N
Gewinde:	zyl. Gewinde DIN 3852 kon. Gewinde DIN 3858
Medium:	Luft, Wasser, Öl, Dampf, etc.

Operating temperature:	max. 150°C
Operating pressure:	up to 60bar
Material:	brass nickel-plated/ polished CW614N and CW617N
Thread:	cyl. thread DIN 3852 con. thread DIN 3858
Medium:	Air, water, oil, steam, etc.