

# 1/3-Verschraubung

Hose connector 1/3

**Betriebstemperatur:** max. 150°C  
**Betriebsdruck:** bis 60bar  
**Werkstoff:** Messing vernickelt/ blank CW614N und CW617N  
**Gewinde:** zyl. Gewinde DIN 3852  
 kon. Gewinde DIN 3858  
**Medium:** Luft, Wasser, Öl, Dampf, etc.

**Operating temperature:** max. 150°C  
**Operating pressure:** up to 60bar  
**Material:** brass nickel-plated/ polished CW614N and CW617N  
**Thread:** cyl. thread DIN 3852  
 con. thread DIN 3858  
**Medium:** Air, water, oil, steam, etc.

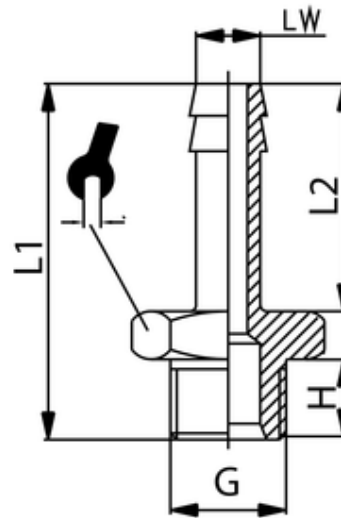

ITV	LW	G	H	L2	L1	SW
401037	13	G1/2	10	35	50	24