

# Stopfen - blank

Stopfen - blank  
Parallel male plug - uncoated  
Tappo, giallo

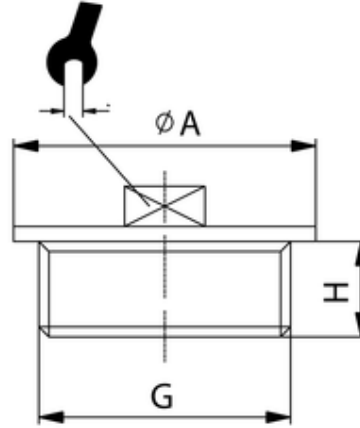

ITV	G	H	$\varnothing A$	sw
401718	G1 1/4	13	48	19

<b>Betriebstemperatur:</b>	max. 150°C
<b>Betriebsdruck:</b>	bis 60bar
<b>Werkstoff:</b>	Messing vernickelt/ blank CW614N und CW617N
<b>Gewinde:</b>	zyl. Gewinde DIN 3852 kon. Gewinde DIN 3858
<b>Medium:</b>	Luft, Wasser, Öl, Dampf, etc.

<b>Operating temperature:</b>	max. 150°C
<b>Operating pressure:</b>	up to 60bar
<b>Material:</b>	brass nickel-plated/ polished CW614N and CW617N
<b>Thread:</b>	cyl. thread DIN 3852 con. thread DIN 3858
<b>Medium:</b>	Air, water, oil, steam, etc.