

# Verschlussschraube konisch

vernickelt, Innensechskant ohne Bund

Male plug conical

Tappo conico a scomparsa con esagono incassato

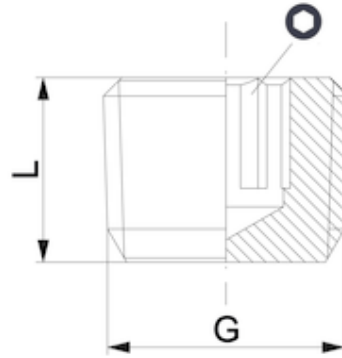

ITV	G	L	isw
401743	R1/4	10	6

<b>Betriebstemperatur:</b>	max. 150°C
<b>Betriebsdruck:</b>	bis 60bar
<b>Werkstoff:</b>	Messing vernickelt/ blank CW614N und CW617N
<b>Gewinde:</b>	zyl. Gewinde DIN 3852 kon. Gewinde DIN 3858
<b>Medium:</b>	Luft, Wasser, Öl, Dampf, etc.

<b>Operating temperature:</b>	max. 150°C
<b>Operating pressure:</b>	up to 60bar
<b>Material:</b>	brass nickel-plated/ polished CW614N and CW617N
<b>Thread:</b>	cyl. thread DIN 3852 con. thread DIN 3858
<b>Medium:</b>	Air, water, oil, steam, etc.