

PTFE

Druckluftschlauch aus Teflon
Teflon tube
Tubo in teflon - neutro

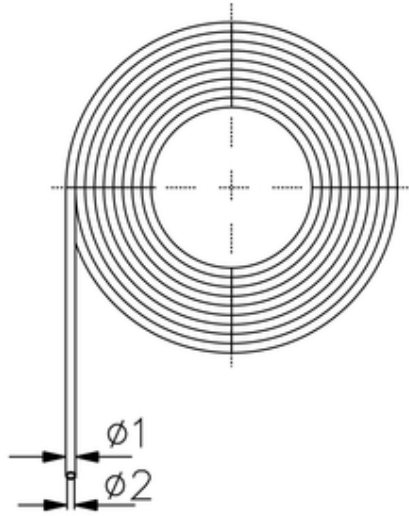

ITV	$\varnothing 1$	$\varnothing 2$
426013	8	6

Betriebstemperatur: -190 °C bis +260 °C Operating temperature: -190 °C to +260 °C Temperatura di esercizio: da -190 °C a +260 °C