

Einhandkupplung

Innengewinde
Coupling female
Rubinetto rapido femmina

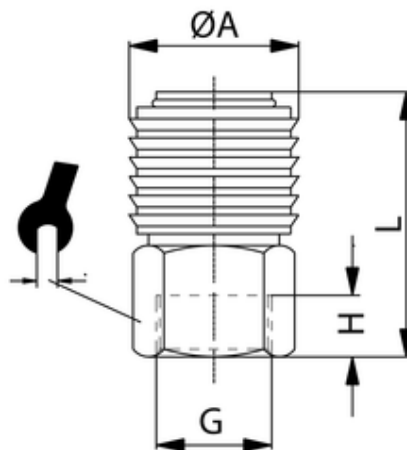

ITV	DN	G	H	ØA	L	sw
430013	7,2	G1/4	9	27	43	22

Körper:	Messing
Body:	brass
Corpo:	ottone
Federn, Sicherungsringe:	Edelstahl
Spring, snap rings:	inox
Molla, anello:	inox
Dichtungen:	Perbunan
Sealing:	perbunan
Guarnizioni:	perbunan
Betriebstemperatur:	-20 °C bis +100 °C
Working temperature:	-20 °C to +100 °C
Temperatura di esercizio:	da -20 °C a +100 °C
Betriebsdruck:	max. 35 bar
Working pressure:	max. 35 bar
Pressione di esercizio:	max. 35 bar
Medium:	Druckluft, Wasser
Medium:	compressed air, water
Fluido:	Aria compressa, acqua
zyl. Gewinde:	DIN EN ISO 228
cyl. threads:	DIN EN ISO 228
Filettatura:	DIN EN ISO 228