

Einhandkupplung vernickelt

mit Schlauchtülle

Coupling with adaptor nickel plated

Rubinetto rapido con portagomma nichelato

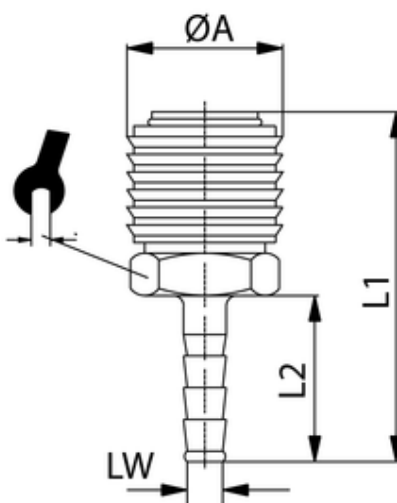

ITV	DN	LW	$\varnothing A$	L1	L2	sw
430023-VN	7,2	6	27	60	25	21

Körper:	Messing
Body:	brass
Corpo:	ottone
Federn, Sprengringe:	Edelstahl
Spring, snap rings:	inox
Molla, anello:	inox
Dichtungen:	Perbunan
Sealing:	perbunan
Guarnizioni:	perbunan
Betriebstemperatur:	-20 °C bis +100 °C
Working temperature:	-20 °C to +100 °C
Temperatura di esercizio:	da -20 °C a +100 °C
Betriebsdruck:	max. 35 bar
Working pressure:	max. 35 bar
Pressione di esercizio:	max. 35 bar
Medium:	Druckluft, Wasser.
Medium:	compressed air, water.
Fluido:	Aria compressa, acqua.
zyl. Gewinde:	DIN EN ISO 228
cyl. threads:	DIN EN ISO 228
Filettatura:	DIN EN ISO 228