

Einhandkupplung

mit Schlauchtülle
Coupling with adaptor

Material: Messing
 Körper: Edelstahl
 Federn, Sprengringe: Perbunan
 Dichtungen: Perbunan
 Betriebstemperatur: -20°C bis +100°C
 Betriebsdruck: max. 35 bar
 Medium: Druckluft, Wasser

material: brass
 body: inox
 spring, snap rings: inox
 sealing: perbunan
 working temperature: -20°C to +100°C
 working pressure: max. 35 bar
 medium: compressed air, water

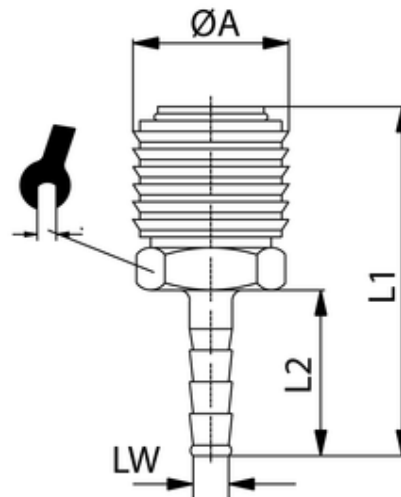

ITV	DN	LW	ØA	L1	L2	sw
430025	7,2	9	27	60	25	21