

**Stecknippel vernickelt**mit Schlauchtülle  
Coupling with adaptor nickel plated

Material: Messing  
 Betriebstemperatur: -20°C bis +100°C  
 Betriebsdruck: max. 35 bar  
 Medium: Druckluft, Wasser

material: brass  
 working temperature: -20°C to +100°C  
 working pressure: max. 35 bar  
 medium: compressed air, water

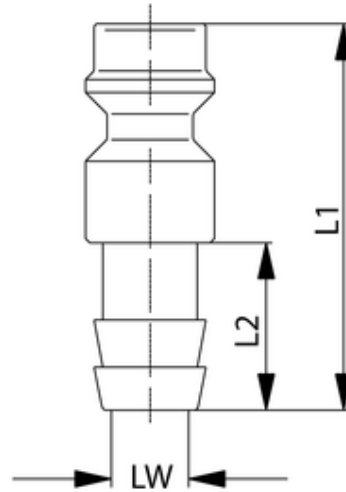

<i>ITV</i>	<i>DN</i>	<i>LW</i>	<i>L1</i>	<i>L2</i>
430034-VN	7,2	8	44	24