

Stecknippel

mit Schlauchtülle
Coupling with adaptor
Innesto rapido con portagomma

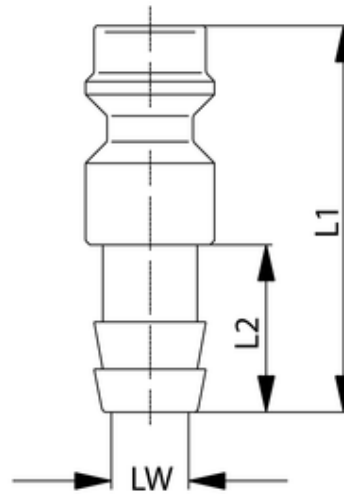

ITV	DN	LW	L1	L2
430034	7,2	8	44	24

Körper:	Messing
Body:	brass
Corpo:	ottone
Betriebstemperatur:	-20 °C bis +100 °C
Working temperature:	-20 °C to +100 °C
Temperatura di esercizio:	da -20 °C a +100 °C
Betriebsdruck:	max. 35 bar
Working pressure:	max. 35 bar
Pressione di esercizio:	max. 35 bar
Medium:	Druckluft, Wasser.
Medium:	compressed air, water.
Fluido:	Aria compressa, acqua.