

Stecknippel

mit Schlauchtülle
Coupling with adaptor

Material: Messing
Betriebstemperatur: -20°C bis +100°C
Betriebsdruck: max. 35 bar
Medium: Druckluft, Wasser

material: brass
working temperature: -20°C to +100°C
working pressure: max. 35 bar
medium: compressed air, water

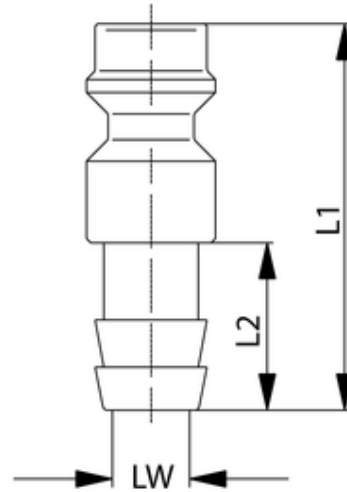

<i>ITV</i>	<i>DN</i>	<i>LW</i>	<i>L1</i>	<i>L2</i>
430035	7,2	9	44	23