

Einhandkupplung vernickelt

Außengewinde

Coupling male nickel plated

Rubinetto rapido maschio nichelato

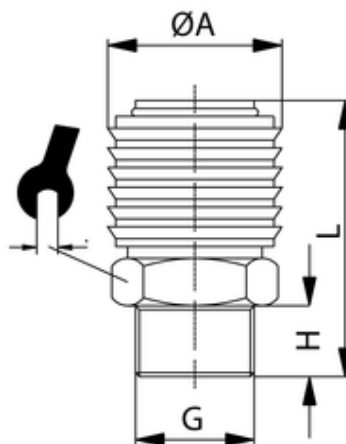

ITV	DN	G	H	$\varnothing A$	L	sw
430203-VN	5	G1/4	8	18	37,5	16

Körper:	Messing
Body:	brass
Corpo:	ottone
Federn, Sprengringe:	Edelstahl
Spring, snap rings:	inox
Molla, anello:	inox
Dichtungen:	Perbunan
Sealing:	perbunan
Guarnizioni:	perbunan
Betriebstemperatur:	-20 °C bis +100 °C
Working temperature:	-20 °C to +100 °C
Temperatura di esercizio:	da -20 °C a +100 °C
Betriebsdruck:	max. 35 bar
Working pressure:	max. 35 bar
Pressione di esercizio:	max. 35 bar
Medium:	Druckluft, Wasser.
Medium:	Compressed air, water.
Fluido:	Aria compressa, acqua.
zyl. Gewinde:	DIN EN ISO 228
cyl. threads:	DIN EN ISO 228
Filettatura:	DIN EN ISO 228