

Einhandkupplung

mit Schlauchtülle
Coupling with adaptor

Material:
Körper: Messing
Federn, Sprengringe: Edelstahl
Dichtungen: Perbunan
Betriebstemperatur: -20°C bis +100°C
Betriebsdruck: max. 35 bar
Medium: Druckluft, Wasser

material:
body: brass
spring, snap rings: inox
sealing: perbunan
working temperature: -20°C to +100°C
working pressure: max. 35 bar
medium: compressed air, water

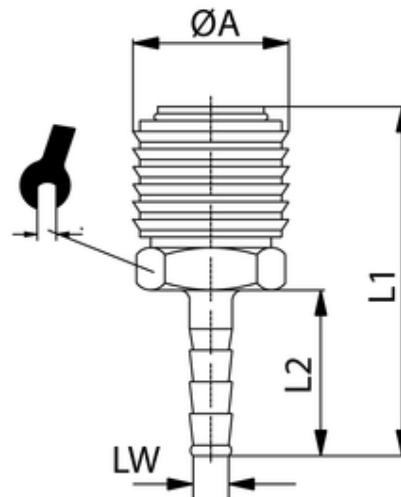

ITV	DN	LW	ØA	L1	L2	sw
430225	5	9	16	46	17	14