

Mini-Kugelhahn Typ 1501

Mini-Kugelhahn Typ 1501
Mini ball valve type 1501

Betriebstemperatur - operating temperature:
Arbeitsdruck - working pressure:
Gehäuse - body:
Kugel - ball:
Griff - handle:
O-Ring - o-ring:
Gewinde - thread:
Einsatzgebiete - applications:

0°C bis +90°C
15 bar
Messing verchromt
Messing verchromt
PA66
PTFE
DIN EN ISO 228
Luft-, Wasser-, Ölkreisläufe
Einsatz auch im mittleren
bis niedrigen Vakuum möglich

0°C to +90°C
15 bar
Brass chrome-plated
Brass chrome-plated
PA66
PTFE
DIN EN ISO 228
Air, Water and Oil dynamics circuits
Use also in medium to low vacuum

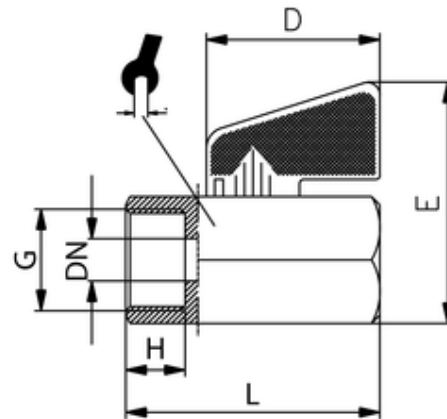
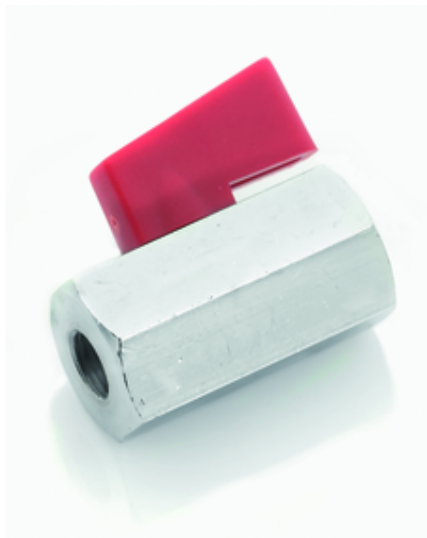

<i>ITV</i>	<i>G</i>	<i>H</i>	<i>L</i>	<i>D</i>	<i>E</i>	<i>DN</i>	<i>SW</i>
500106	G3/4	12	54	30	47	12	30