

# 3-Wege-L-Kugelhahn

Three-way ball valve &quot;L&quot;;  
Valvola a sfera a 3 vie L

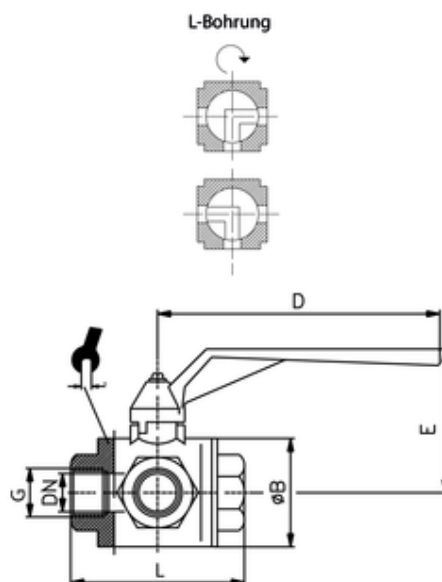

ITV	G	DN	ØB	L	D	E	P*	sw
505003	G1/4	10	39	77	125	65,5	55	22

Betriebstemperatur: -20 °C bis +150 °C ohne Dampf  
Operating temperature: -20 °C to +150 °C without steam  
Temperatura di esercizio: da -20 °C a +150 °C senza vapore

Körper: Messing vernickelt  
Body: brass nickel-plated  
Corpo: ottone nichelato

Kugel: Messing verchromt  
Ball: brass chrome-plated  
Sfera: ottone cromato

Griff: Aluminium, lackiert  
Handle: aluminium, painted  
Leva: alluminio, verniciato

O-Ring: NBR  
O-ring: NBR  
O-Ring: NBR

Dichtung: PTFE  
Seal: PTFE  
Guarnizione: PTFE

Gewinde: DIN EN ISO 228  
Thread: DIN EN ISO 228  
Filettatura: DIN EN ISO 228

Medien: Industrie-Pneumatik, Heizung, Sanitär, beständig gegen Heißwasser, Gasen und Druckluft.  
Media: Industrial pneumatics, heating, sanitation, resistant to hot water, gases and compressed air.  
Media: Per impieghi in automazione industriale e per l'utilizzo con aria compressa, acqua, negli impianti di condizionamento, sanitario, di riscaldamento e gas.