

3-Wege-T-Kugelhahn

Three-way ball valve "T"

Betriebstemperatur - operating temperature

Gehäuse - body:

Kugel - ball:

Griff - handle:

Dichtung - seal

O-Ring - o-ring:

Zylindrisches Gewinde - zyl. thread

Einsatzgebiete - applications

-20°C bis +150°C ohne Dampf

Messing, vernickelt

Messing, verchromt

Aluminium, lackiert

PTFE

NBR

DIN EN ISO 228

Industrie-Pneumatik, Heizung,

Sanitär, beständig gegen

Heißwasser, Gasen & Druckluft

-20°C bis +150°C without steam

Brass, nickel-plated

Brass, chrome-plated

Aluminium, painted

PTFE

NBR

DIN EN ISO 228

Industrial pneumatics, heating

sanitation, resistant to hot water,

gases and compressed air

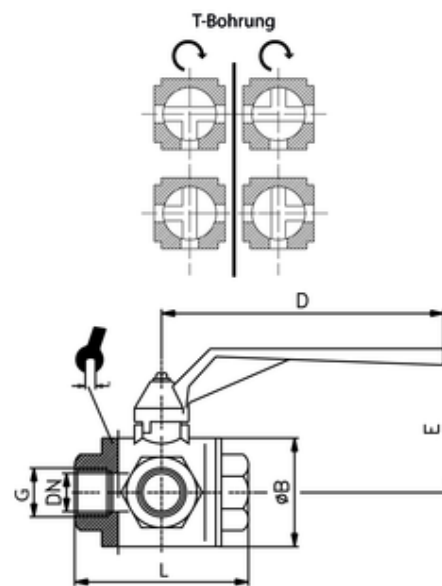

ITV	G	DN	ØB	L	D	E	P	SW
506006	G3/4	18	47	92	145	83,5	50	34

*P = Druck / pressure [bar]