

Kugelhahn

mit Entlüftung

Ball valve with vent

Valvola a sfera lucchettabile con scarico

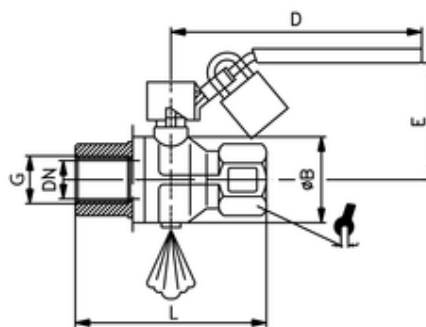

ITV	G	DN	L	D	E	P*	sw
507403	G1/4	8	45	96	46	14	20

voller Durchgang

full opening area

Passaggio Totale

Betriebstemperatur: -10 °C bis +100 °C

Operating temperature: -10 °C to +100 °C

Temperatura di esercizio: da -10 °C a +100 °C

Körper: Messing vernickelt

Body: brass nickel-plated

Corpo: ottone nichelato

Kugel: Messing verchromt

Ball: brass chrome-plated

Sfera: ottone cromato

Griff: Stahl, beschichtet

Handle: Steel, lined

Leva: In acciaio rivestito

Dichtung: PTFE

Seal: PTFE

Guarnizione: PTFE

Gewinde: DIN EN ISO 228

Thread: DIN EN ISO 228

Filettatura: DIN EN ISO 228

Medien: Industrie-Pneumatik, Hydraulik, Heizung, Sanitär, beständig gegen Heißwasser, Benzin, Diesel, Kerosin, Säuren, Gasen und Druckluft.

Media: Industrial pneumatics, hydraulics, heating, sanitation, resistant to hot water, petrol, diesel, kerosene, acids, gases and compressed air.

Media: Per impieghi in automazione industriale e per l'utilizzo con aria compressa, acqua, negli impianti di condizionamento, sanitario, di riscaldamento, petrolio, gasolio, kerosene, acidi e gas.