

Schlauchschellen

nach DIN 3017 - Edelstahl
Stainless steel hose holder according to DIN 3017

mit Schneckengewinde
vollständig aus Edelstahl 1.4301

with screw flight
completely made of stainless steel 1.4301

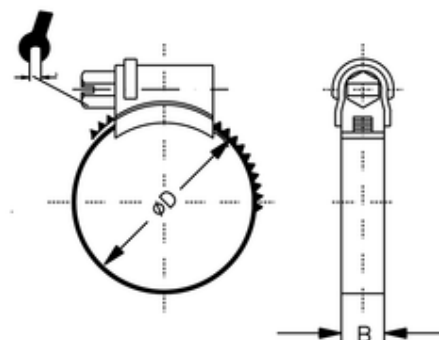

ITV

652060

B

9

ØD

40-60