

# Schlauchschellen

nach DIN 3017 - Edelstahl  
Stainless steel hose holder according to DIN 3017

mit Schneckengewinde  
vollständig aus Edelstahl 1.4301

with screw flight  
completely made of stainless steel 1.4301

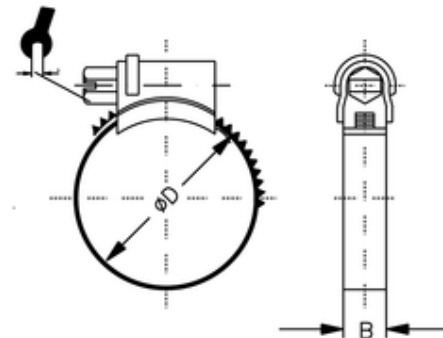

**ITV**

652110

**B**

9

**ØD**

90-110