

# Schlauchschellen

nach DIN 3017 - Edelstahl  
Stainless steel hose holder according to DIN 3017

mit Schneckengewinde  
vollständig aus Edelstahl 1.4301

with screw flight  
completely made of stainless steel 1.4301

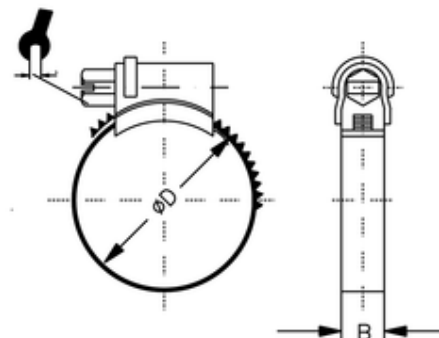

<i>ITV</i>	<i>B</i>	<i>ØD</i>
653040	12	25-40