

Schlauchschellen

nach DIN 3017 - Edelstahl
Stainless steel hose holder according to DIN 3017
Fascetta Fermatubo in acciaio inox DIN 3017

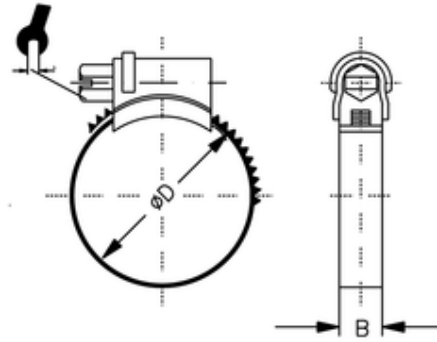

ITV	B	ØD
653050	12	32-50

mit Schneckengewinde
with screw flight
vite senza fine

Material:	Edelstahl 1.4301
Material:	stainless steel 1.4301
Materiale:	acciaio inox 1.4301