

# Schlauchschellen

nach DIN 3017 - Edelstahl  
Stainless steel hose holder according to DIN 3017  
Fascetta Fermatubo in acciaio inox DIN 3017

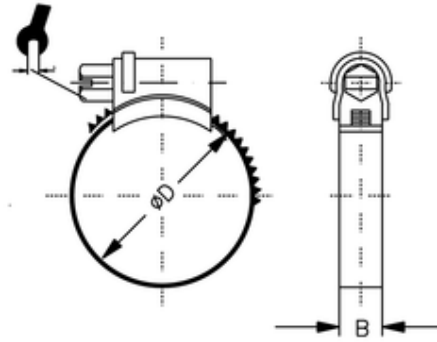

ITV	B	ØD
653090	12	70-90

mit Schneckengewinde  
with screw flight  
vite senza fine

Material:	Edelstahl 1.4301
Material:	stainless steel 1.4301
Materiale:	acciaio inox 1.4301