

Mini-Kugelhahn 655

Steckausführung/AG konisch

Male mini ball valve 655 (push-in, conical)

Valvola a sfera micro 655 maschio conico e attacco automatico

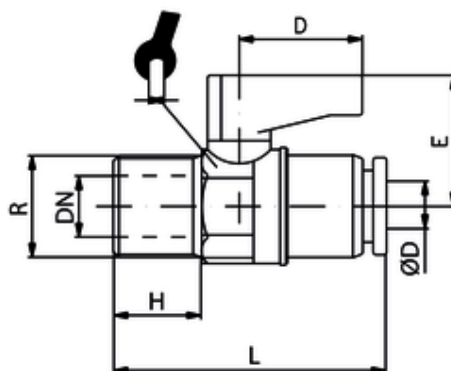

ITV	R	ØD	L	H	D	E	DN	sw
65504	R1/4	6	44	11	19,5	21,5	5,5	14

Betriebstemperatur:	-20 °C bis +80 °C
Operating temperature:	-20 °C to +80 °C
Temperatura di esercizio:	da -20 °C a +80 °C
Betriebsdruck:	20 bar
Inlet pressure:	20 bar
Pressione di esercizio:	20 bar
Körper/Kugel:	Messing verchromt
Body/ball:	brass chrome-plated
Corpo/sfera:	ottone cromato
Griff:	PA66
Handle:	PA66
Leva:	PA66
O-Ring:	NBR 70
O-Ring:	NBR 70
O-Ring:	NBR 70
Gewinde:	DIN EN ISO 10226 (DIN 2999)
Thread:	DIN EN ISO 10226 (DIN 2999)
Filettatura:	DIN EN ISO 10226 (DIN 2999)
Einsatzgebiete:	Luft-, Wasser-, Ölkreisläufe, Einsatz auch im mittleren bis niedrigen Vakuum möglich.
Applications:	Air, Water and Oil dynamics circuits, use also in medium to low vacuum.
Campo di applicazione:	Aria, acqua e circuiti oleodinamici; e' possibile l'utilizzo per medio/ basso vuoto pneumatico.