

# Schlauchschellen

nach DIN 3017

Hose holder according to DIN 3017

Fascetta Fermatubo DIN 3017

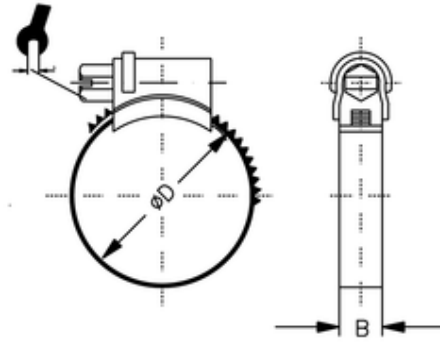

ITV	B	ØD
657410	12	90-110

mit Schneckengewinde

With screw flight

vite senza fine

Material:	Stahl, glanz verzinkt.
Material:	steel, glossy zinc-coated.
Materiale:	acciaio, zincato lucido.
Schraube:	SW7/ SW8
Screw:	AF7 / AF8
Vite:	CH7 / CH8