

# Schlauchschellen

nach DIN 3017  
Hose holder according to DIN 3017

mit Schneckengewinde

Materialien:  
Oberfläche:  
Bandabmessung: 12mm Breite  
Bandabmessung: 8mm Breite  
Schnecke:

Stahl  
glanz verzinkt  
S=0,8mm  
S=0,65mm  
SW7 / SW8  
einsatzgehärtet

with screw flight

Materials:  
Surface:  
Belt: 12mm wide  
Belt: 8mm wide  
Screw:  
steel  
glossy zinc-coated  
S=0,8mm  
S=0,65mm  
CH7 / CH8  
case hardened

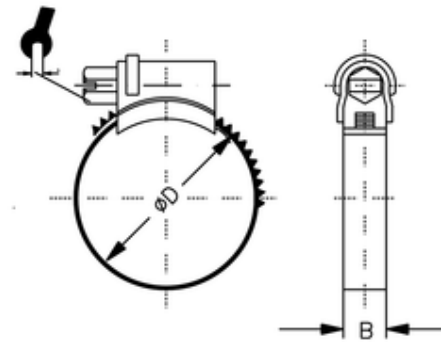

**ITV**

657450

**B**

12

**ØD**

130-150